



HOSE PRODUCTS, INC.
A Kuriyama Group Company

PHP110 Ultra Duty Hydraulic Swage Hose Repair Machine

Operational Manual





The Hydraulic Swage Hose Mending Machine has been approved by Piranha® Hose Products for use in the repair of Thermoplastic Sewer Cleaning Hose. Piranha Hose Sizes 1/8" – 1 ¼" size sewer cleaning hose can be repaired or mended using this machine, contingent upon use of proper dies, pushers and adaptors.

All sewer hose and repair fitting tools are manufactured to the National Solid Waste Management Association (formally WEMI) standards. To protect against PERSONAL INJURY OR DEATH, inspect and repair sewer hose only pursuant to and in compliance with NSWMA standards.

When mending sewer cleaning hose, the hose, the mending equipment, the swage equipment, including dies and fittings, MUST be of the same manufacturer. The use of end fittings and assembly tooling other than that supplied or recommended by Piranha® Hose Products is at the sole risk and liability of the user and voids all Piranha Hose Products warranties.

***** WARNING *****



FAILURE TO COMPLY WITH THE ABOVE RESTRICTIONS MAY RESULT IN HOSE BURST OR COUPLING BLOWOFF WHICH MAY LEAD TO PROPERTY DAMAGE, SERIOUS INJURY OR DEATH!

Thermoplastic sewer cleaning hose has been designed to meet the harsh environmental conditions found in high pressure sewer cleaning applications. The National Solid Waste Management Association (Formally WEMI) call for sewer cleaning hose standardization, for color-coded, standardized, hose, fittings and repair equipment.

The outer cover of the hose is a standardized color for the following PSI rating:

Orange Color: 2500 PSI	Blue Color: 3000 PSI	Green Color: 4000 PSI
Black Color: 4000 PSI - High Burst	Red Color: 5000 PSI	

End fittings and menders for thermoplastic hose are not interchangeable. It is essential that hose, end fittings, menders, and tooling be properly matched. Identification of Piranha® Hose Products is simple and easy. The inner tube of all Piranha® Sewer Cleaning Hose is yellow, as assigned by WASTEC (Waste Equipment Technology Association) for the manufacture identification code. To assure proper matching of all components, the hose tube material, end fittings, menders, and tooling must be color coded yellow. While there may be several sources of end fittings and assembly tooling that bear the yellow color coding, for safety and reliability-end fittings and assembly tooling should be purchased directly from Piranha Hose Products.

A Piranha® supplied swaging machine is required for the installation of end fittings and menders. All repair and mending tooling is designed and produced to be compatible with the Piranha® Hose Products supplied swaging machines.

TABLE OF CONTENTS

I. HOSE SECTION	5
A. Sewer Cleaning Hose Inspection	5-6
B. Hose In-Service Inspection	6
II. ASSEMBLY INSTRUCTIONS- HOSE MENDER	7
A. Step 1	8
The UEM110-Ultra Kickstand.....	9
B. Step 2.....	11
C. Step 3 & 4	12
D. Step 5 & 6	13
III. ASSEMBLY INSTRUCTIONS- HOSE ENDS	15
A. Step 1a & 2a	16
B. Step 3a & 4a.....	17
C. Step 5a	18
D. Step 6a	19
IV. MAINTENANCE & STORAGE	20
A. Maintenance & Storage	20
B. Packaging and Shipping After Usage.....	21
V. PARTS OVERVIEW & BREAKDOWN.....	22



Male End



Hose Mender



Female End



Pusher Plate



Die Set



Swage Machine

SECTION I
HOSE INSPECTION

Sewer Cleaning Hose Inspection

High pressure water is utilized in sewer cleaning applications. Piranha® Hose Products Sewer Cleaning Hose is designed for water use only.

Upon receipt of the hose, it should be taken off the reel and inspected for any flaw or damage. **Any damage or flaw should be reported to the supplier immediately.**

From time to time, while in service, the hose should be inspected from one end to other end for damage that may have occurred while in use. The hose may be repaired, (mended) utilizing the instructions to follow later in this manual.

Inspection:

1. Unreel the hose assembly and disconnect the hose from both the pump and storage or truck reel. Carefully inspect the hose for evidence of damage. The following are conditions that will require hose replacement, mending or end replacement.
 - a. Hose Burst – A hole in the outer jacket to the inner tube.
 - b. Cover damage exposing the braid of reinforcing fabric.
 - c. Any areas containing a blister or bubble in the outer cover.
 - d. Any kinking or hose collapse.
 - e. Any leakage from the hose end.
2. Determine the total number of areas requiring repair plus the number of mending fittings already on the hose. (Note: Piranha® recommends only two mending repairs per hose) A hose mender should not be located within 50 feet of the hose end or another mender.
3. Cut out the damaged areas of the hose a distance of at least 12 inches on each side of the damaged area. Utilize a sharp knife or bench mounted cut off tool. The hose **MUST** be cut squarely.
4. Discard the damaged section of the hose.
5. Inspect both of the hose ends very carefully for any of the following conditions:
 - a. Any signs of water in the fabric reinforcement layer. If any water is present within the reinforcing layer, the hose end(s) should **NOT** be mended.
 - b. Any indication of incomplete bonding of the inner tube to the fabric reinforcement or the fabric reinforcement to the outer cover. The entire circumference should be inspected. If any lack of bonding is present, the hose end(s) should not be mended.
 - c. Check the color of the hose inner tube. Hose menders, ends, dies and pusher plate should be ordered for the manufacture as stated above in this manual. Piranha's® inner tube color is yellow.

6. As noted, if any of the conditions contained in item #5 are not satisfactory, hose end(s) shall not be installed. On any unsatisfactory end, cut off an additional 4 to 5 feet of hose and discard.
7. Please note: **NEVER** repair a Piranha Hose Products hose with a mender or fitting from another manufacturer.

NEVER use dies or a pusher plate from another manufacturer. Each hose manufacturer has different dimensions for fittings and hose. Hose burst may occur and could result in damage to the equipment or personal injury.
8. Proceed on to the assembly instructions in the next section when all of the above

Hose In-Service Inspection:

Hose assemblies in-service should be frequently inspected daily or a weekly basis for the following conditions:

1. Hose movement on the hose end or mender.
2. Damaged cover exposing the fabric reinforcement.
3. Cover showing blisters or bubbles.
4. Hose kinking, collapse, flat spots or signs of stretching.
5. Fittings cutting into hose at the edge of connection.

Replace the hose if any of these conditions are present!



Above: An example of damaged hose which should be replaced.

WARNING

Read and understand all instructions covered in the hydraulic swage machine repair manual before usage.

FAILURE to do so could result in **INJURY** or **DEATH**.

If swage machine is stored on its side, the jack ram can become air bound. To remedy this situation, the die plate must be jacked up 2-3," then, by opening the valve screw (turn counter clockwise), the die plate will lower to nested position. Then, by closing the valve screw (turn clockwise), the machine will be ready for use.

SECTION II

ASSEMBLY INSTRUCTIONS

HOSE MENDER

Assembly Instructions – Hose Mender

Step #1 When the area of repair has been identified, be sure to cut with a knife or a bench mounted cut-off tool as square as possible the area of hose to be mended.

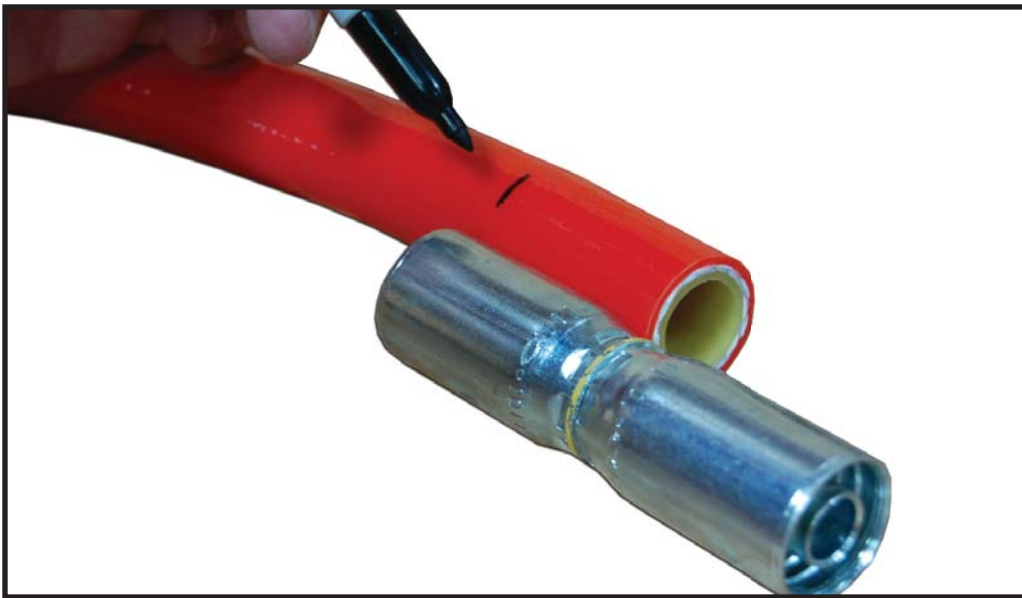
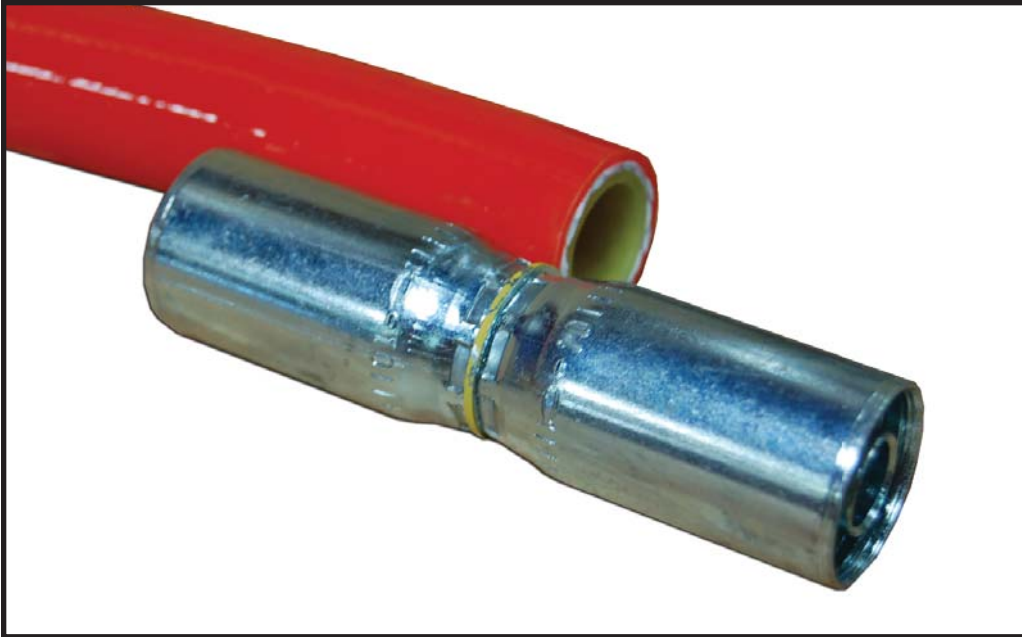

For proper insertion depths visit the Piranha Hose website www.piranhahose.com or contact Piranha Hose at 800-250-5132

The PHP110-Ultra Kickstand

Your PHP110-Ultra has come equipped with a 'kickstand' to help keep it upright and stable when used. Just slide the tube through the rear of the base to allow added support when operating the machine.



Cut the hose ends off square. Using a ruler measure the distance from the end of the hose equivalent to the "Insert Depth" shown on the chart on page 8. Mark the hose with a marker.

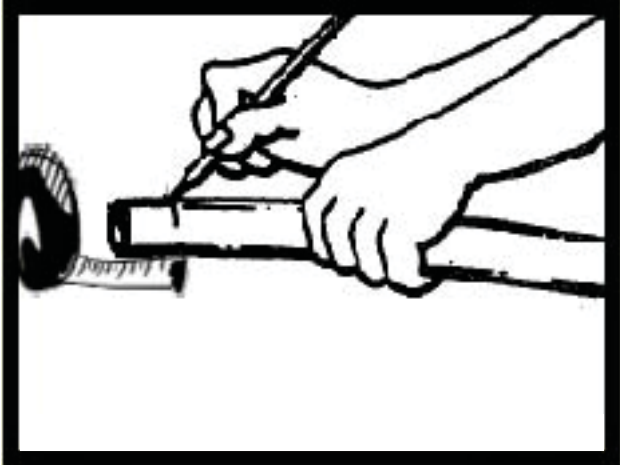

Insert hose into the fitting or mender to the insertion depth mark on the hose. You may have to use a twisting motion or a water soluble soap solution to assist you.

DO NOT USE OIL TO ASSEMBLE THE FITTING OR MENDER ON THE HOSE.

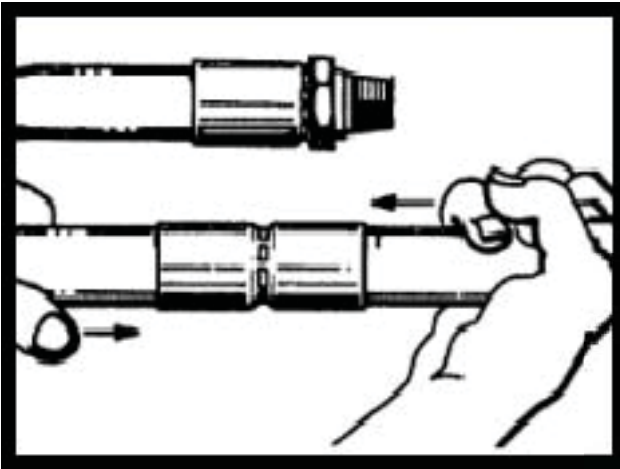

Place the hose with the fitting or mender in the swage machine along with the proper dies and pusher. Position the dies so that their splits are away from the openings. Lubricate insides of the dies with biodegradable oil. **Please Note: An end fitting will require 1 set of dies and 1 pusher. A mender will require 2 sets of dies.**



Inspect the fitting or mender. The swage should be uniform. The bulge appearing on the fitting after the swaging operation should be minimum distance from the edge of the fitting or mender. The chart below gives this distance per hose size.

STANDARD PIRANHA® SEWER HOSE				
END FITTINGS			MENDER	
HOSE SIZE	LENGTH (x)	DIAMETER	LENGTH (y)	DIAMETER
LL-6	1.040	0.693	NA	NA
SHBK-08	1.000	0.900	1.050	0.900
LL -8	1.250	0.850	1.050	0.850
-10	1.313	1.030	1.000	1.030
-12	1.125	1.212	1.000	1.212
-16	1.875	1.485	1.125	1.485
-20	1.430	1.860	1.750	1.860

Adaptor Needed

Step #2 Using the correct sets of dies (2 sets needed) lubricate the inside and outside of the die sets with a biodegradable oil.



Step #3

Slide the Hose up through the bottom die set and put into the hose mender.
Repeat this from the top – place hose down on the other end of the hose mender.

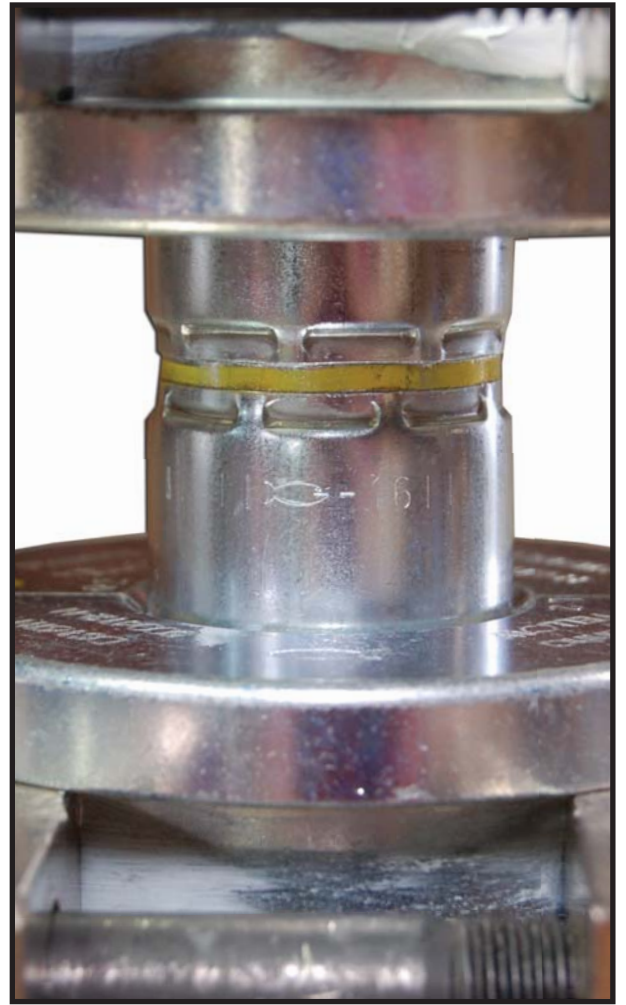

Step #4

Tighten the bolts with a wrench to hold the dies firmly in place.

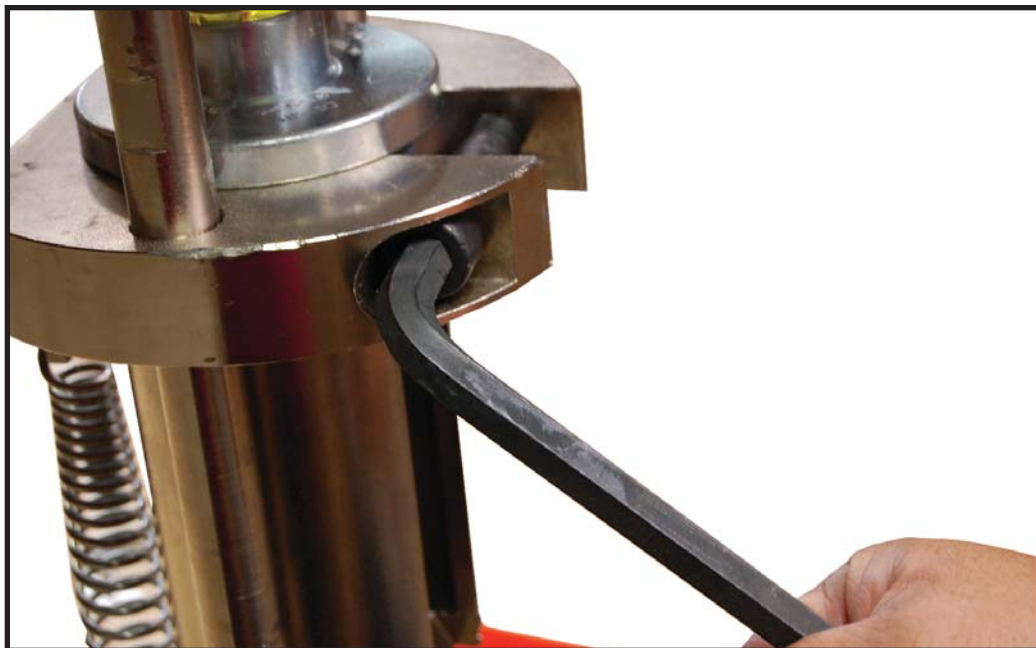

Step #5 Pump the jack with the handle provided until the dies are compressed together.

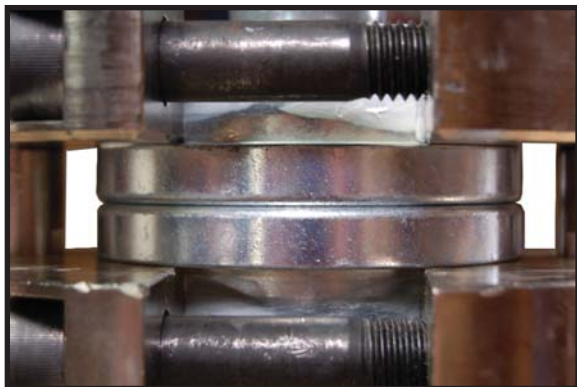

Step #6 Using the handle provided, turn the valve screw counter clockwise to release the pressure of the jack to lower the die holder to its nested position. Loosen the bolts with a wrench, tap the dies out of the machine and the hose mender should be secured to hose at the location marked on the hose in Step #1.



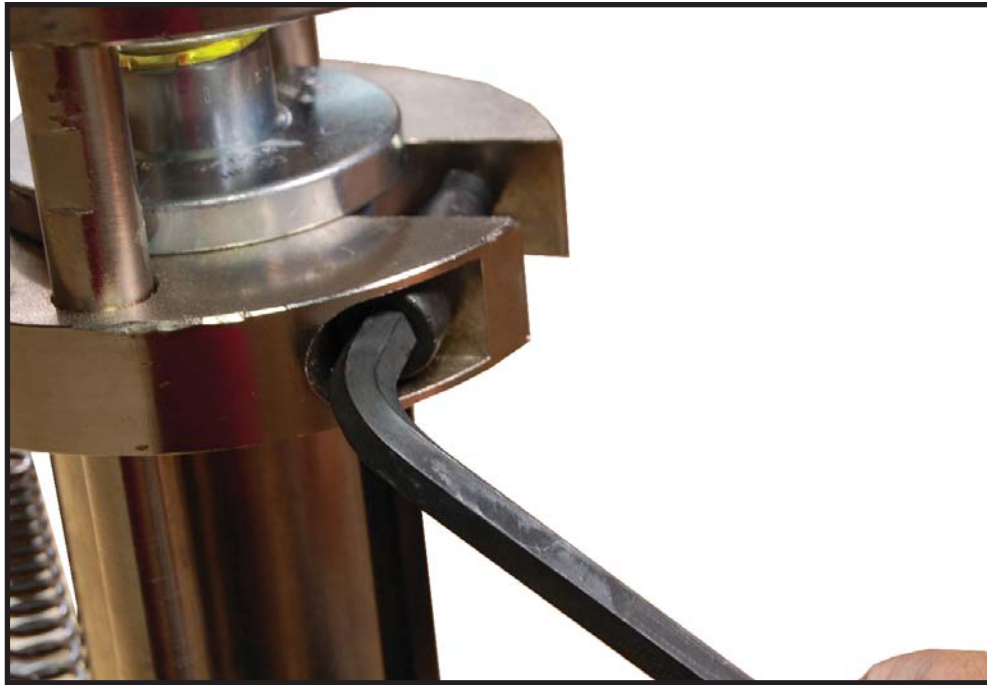

The handle that is used to jack up the die holder plate is also used to open and close the valve screw. By turning the screw counter clockwise, the die plate will lower. To raise the plate, the valve should be turned to a closed position (clockwise to a stopped position), before pumping.

Inspect the hose mender assembly to insure:

- a. That there is no hose movement in the mender.
- b. The insertion mark on the hose (Step #1) is still located on each end of the mender.
- c. The hose assembly is now complete and ready for use (See In-service Inspection for details before use).

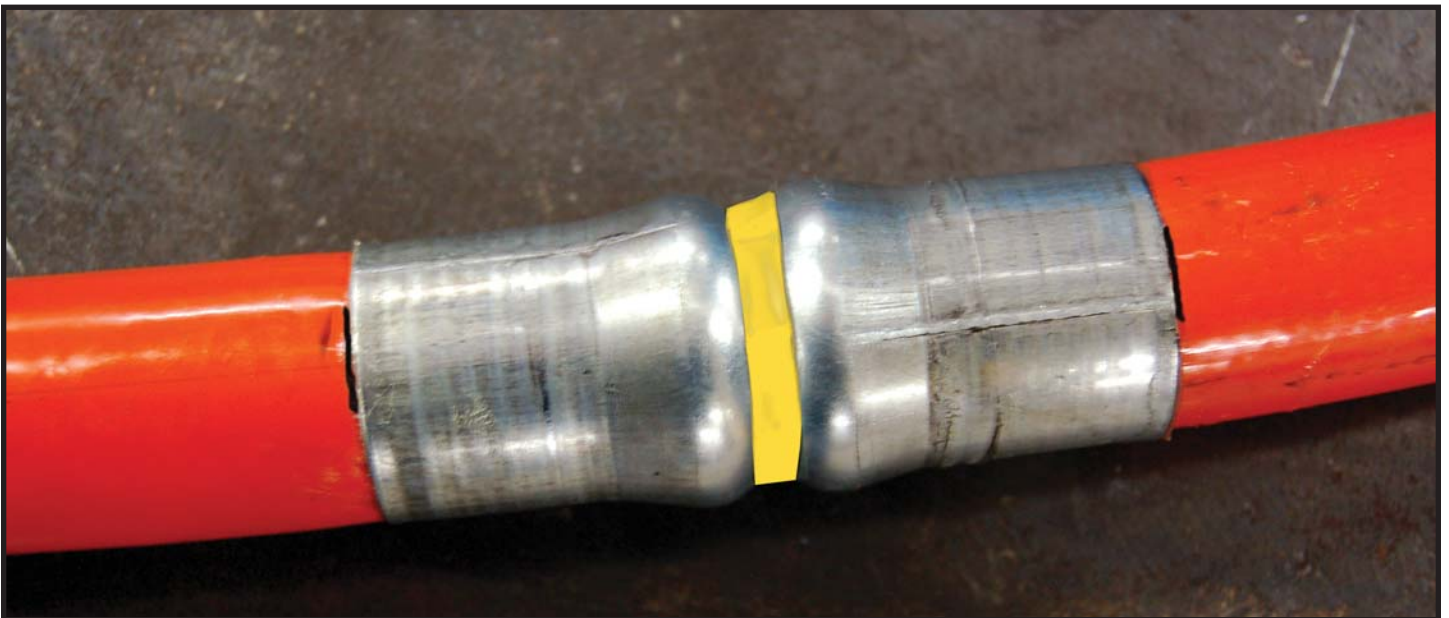

SECTION III
ASSEMBLY INSTRUCTIONS
HOSE ENDS

Assembly Instructions – Hose Ends

- Step #1a Cut off damaged hose end roughly 12" from the end of the hose. Cut with a knife or bench mounted cut-off tool as square as possible. Use our published Insertion Depth. See Hydraulic Swage Instructions as a reference and mark the hose with a marking tool, as shown below

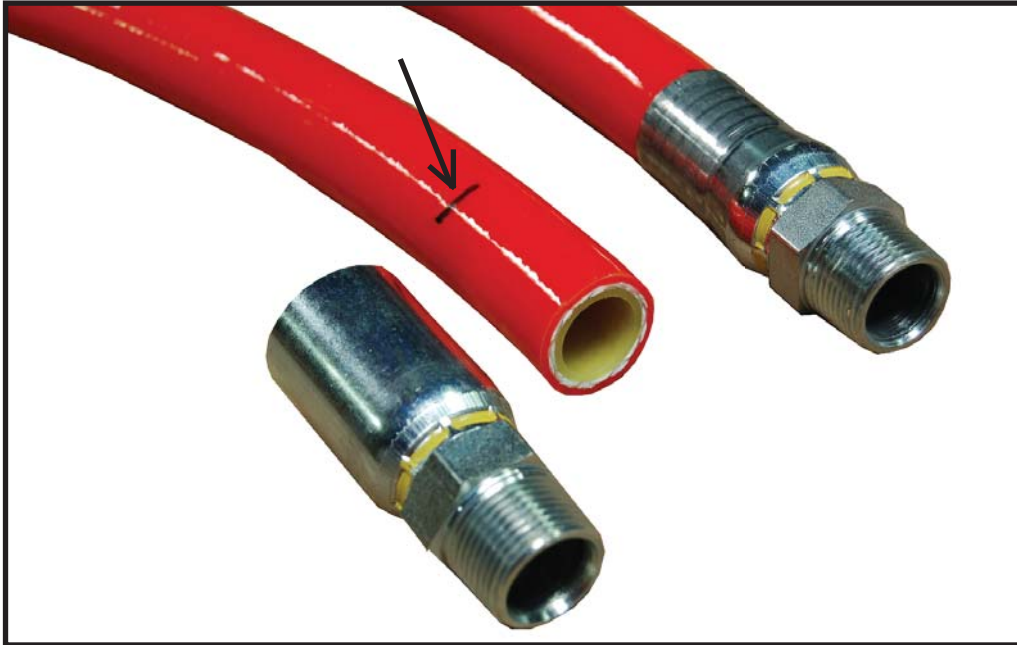

- Step #2a Using one set of dies and the pusher plate lubricate the inside and outside of the die set and pusher plate with a biodegradable oil. Place the die set in the bottom and the pusher plate in the top of the Piranha® Hydraulic swage machine.



Step #3a Slide the Hose End onto the end of the hose, up through the die set and up to the pusher plate with the threaded end into the pusher plate.



Step #4a Tighten bolts with a wrench to hold the die set and pusher plate in place.

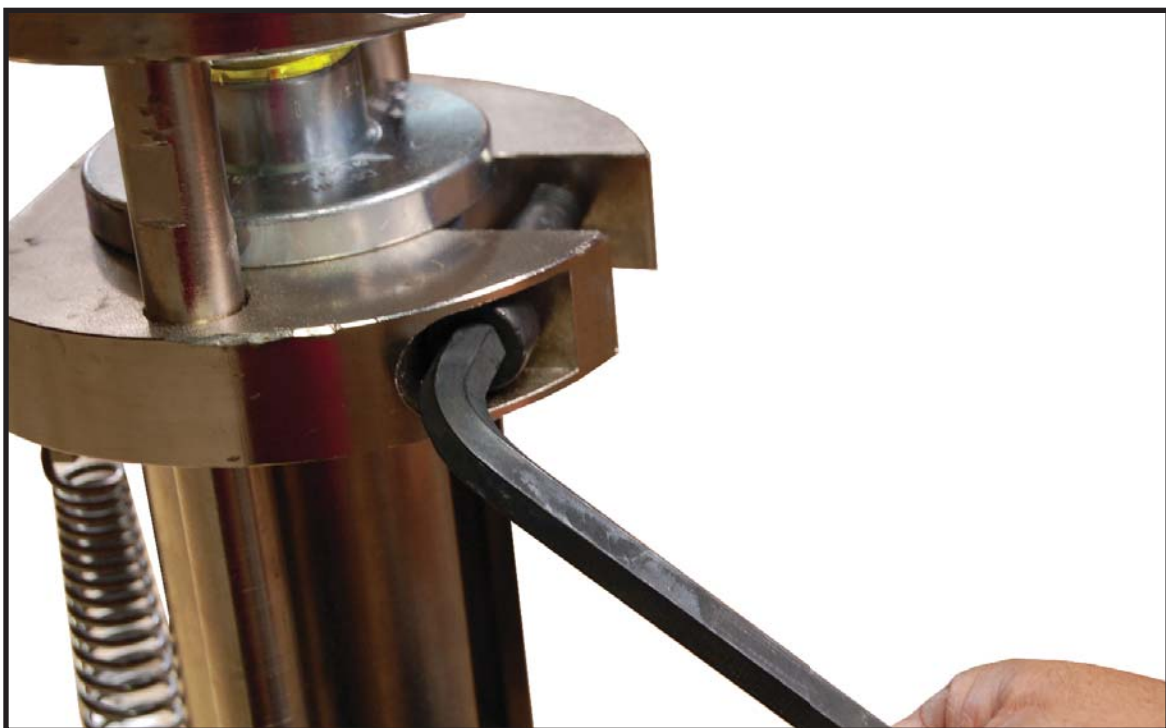

Step #5a Pump the jack with the handle provided until the dies depress completely together into the pusher plate.

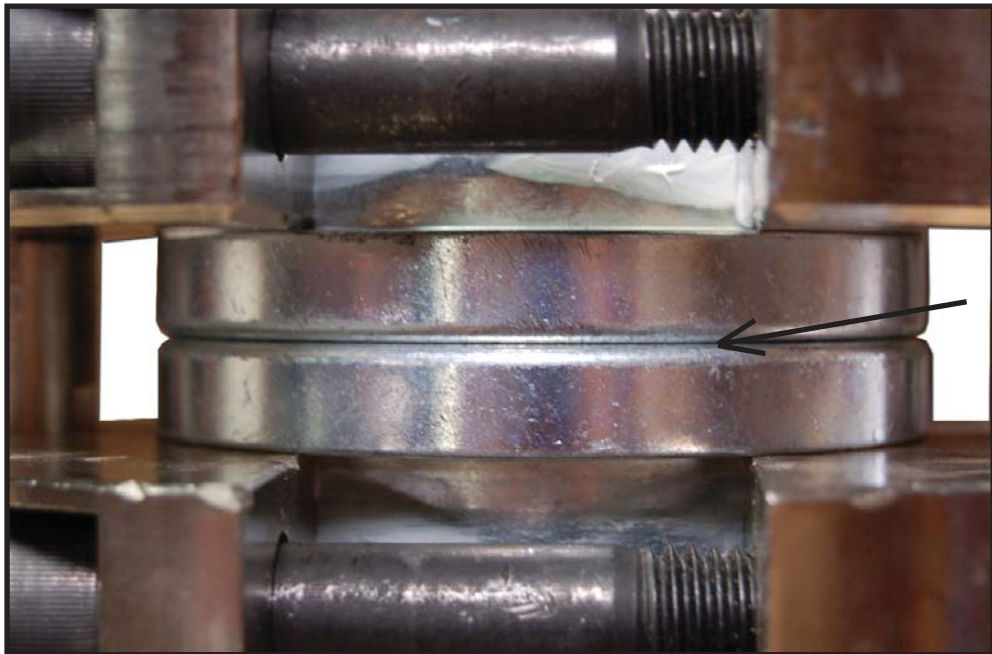
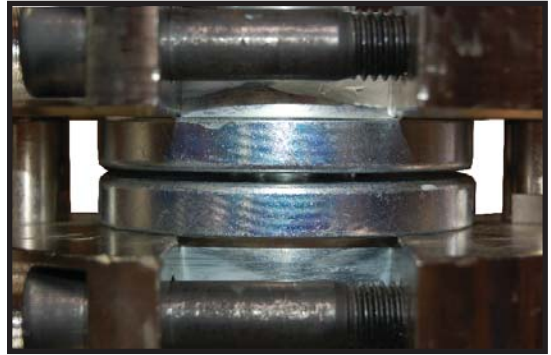

Step #6a Using the handle provided, turn the valve screw counter clockwise to release the pressure of the jack to lower the die holder to its nested position. Loosen the bolts with a wrench, tap the die set and pusher plate out of the machine and the male hose end should be secured to hose at the location marked on the hose in Step #1.



Inspect the hose end assembly to insure:

- a. That there is no hose movement in the male hose end.
- b. The insertion mark on the hose (Step #1a) is still located on the end of the hose end.
- c. The hose assembly is now complete and ready for use (See In-service Inspection for details before use).

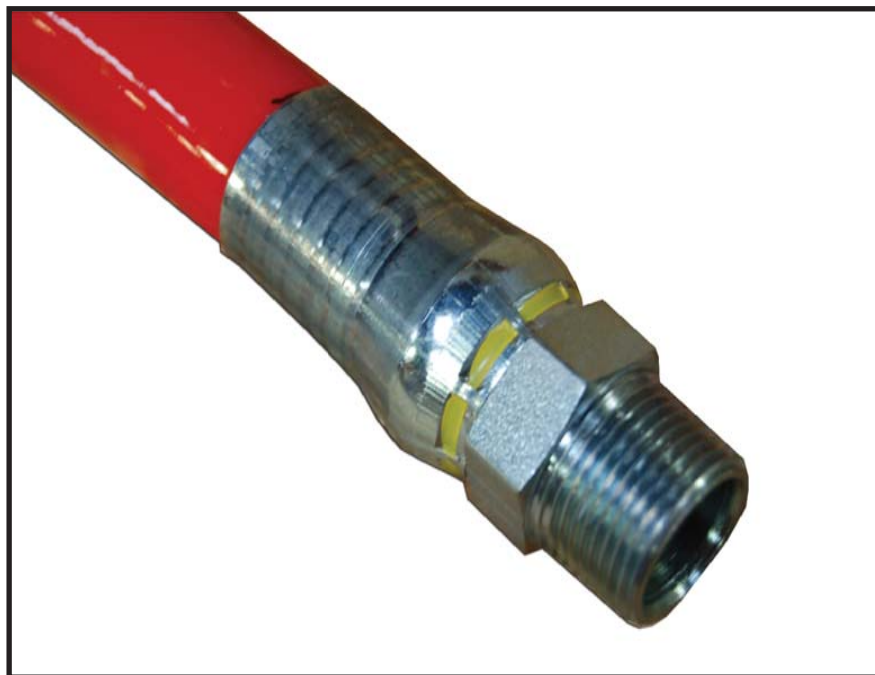

SECTION IV

MAINTENANCE &

STORAGE

Maintenance and Storage of the Piranha® Hydraulic Swage Machine

Always use and store your Piranha® Hydraulic Swage Machine in an up-right position. This will keep the hydraulic fluid in the proper location in the jack. If you lay it down it may leak hydraulic fluid and the jack will possibly fail to compress properly when used. Use a Piranha® storage box or similar container. Wipe it clean after use. Keep this manual with the Piranha® Hydraulic Swage Machine for easy reference.

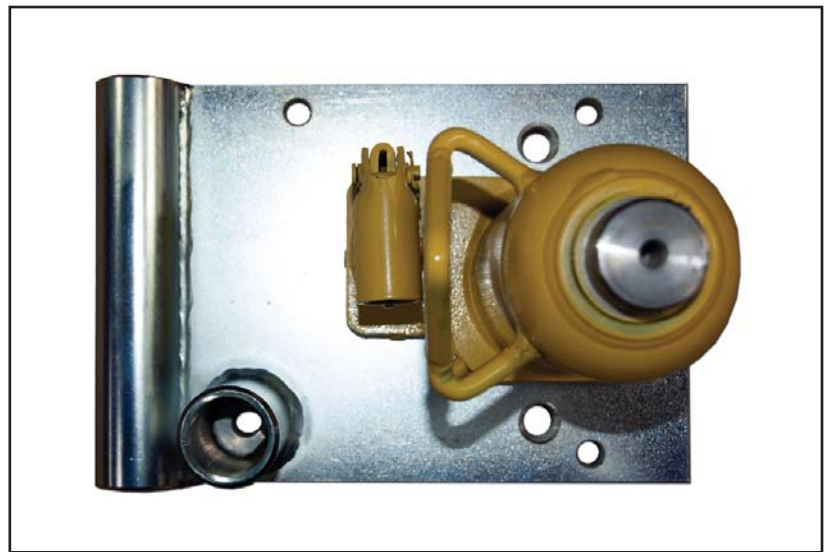

Top view of the PHP110-Ultra base, showing the mounting holes to attach the machine to a workbench or cleaning truck deck, and measurements below for mounting.

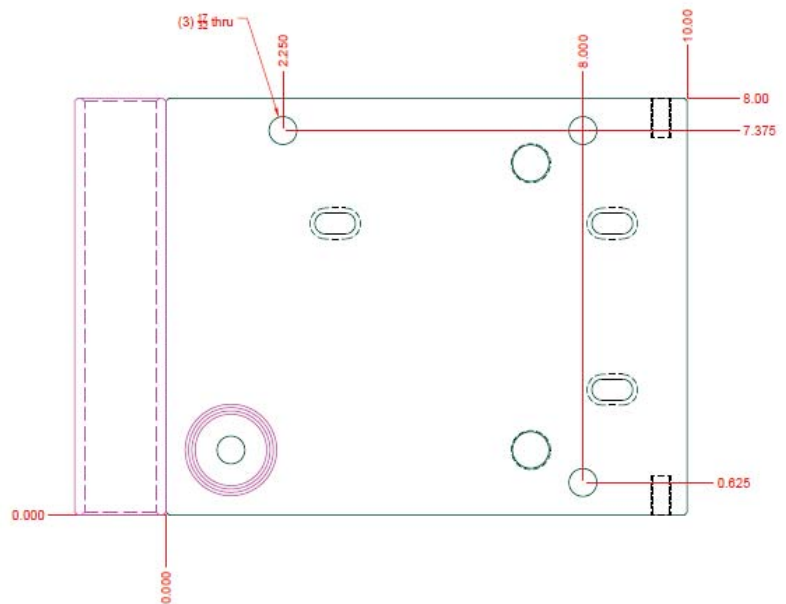

Packaging and Shipping your PHP110-Ultra Machine after Use.

Remove the handle of your machine and flip it upside down and refit. This 'tighter' fit will allow your machine to fit into its original Piranha shipping box. Failure to do so will increase shipping cost.



PHP110 Ultra Mending Machine

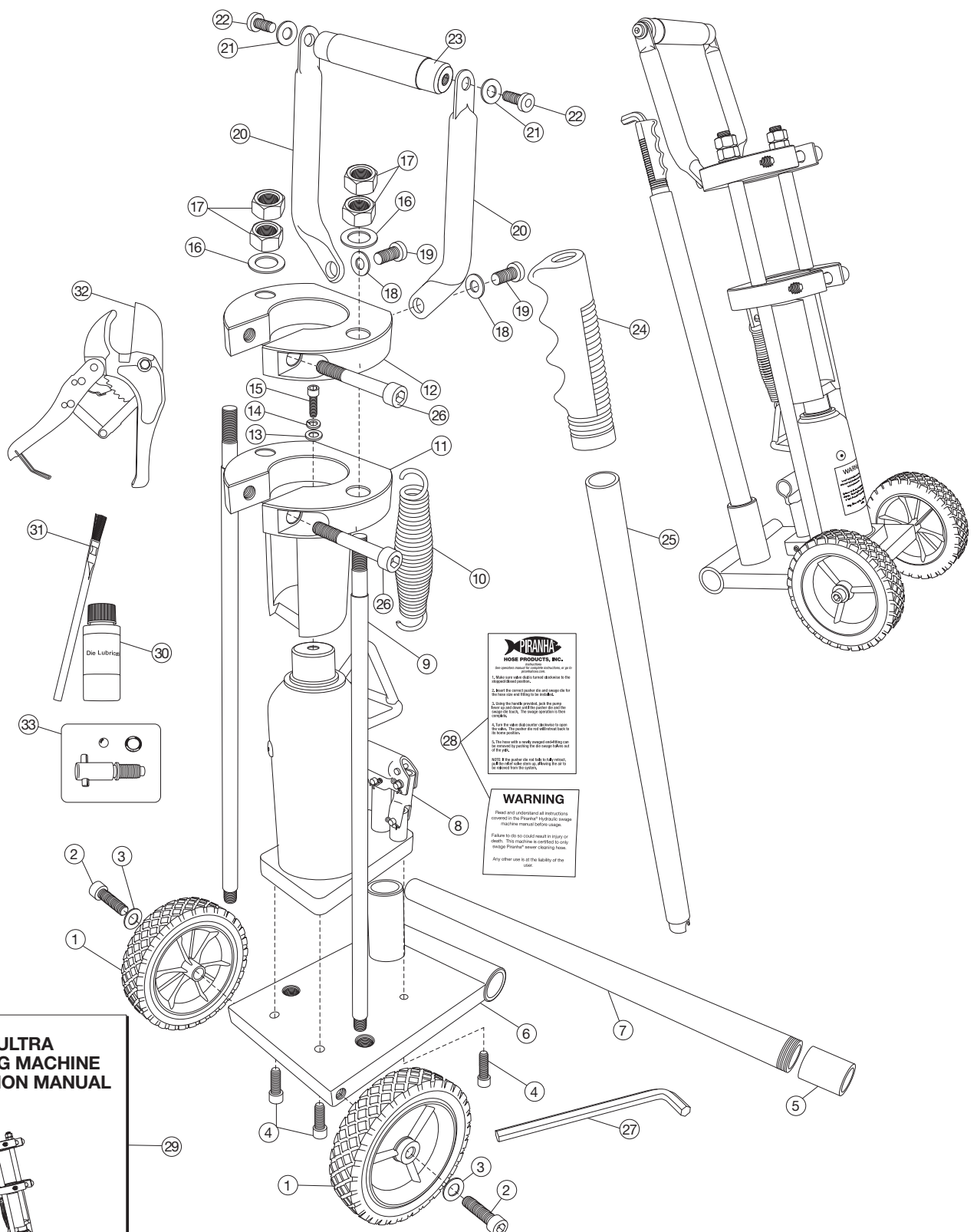

PIRANHA
HOSE PRODUCTS, INC.
www.piranha-hose.com or 1-800-250-5132

1. Make sure you use the correct die and size die for the hose you are mending.
2. Mark the correct inside dia and length die for the hose you are mending. Push the pump handle down and the die will move back. The pump handle is now ready.
3. For the die to be in the correct position to open the die, you must be in the correct position. The pump handle is now ready.
4. The pump handle is now ready to be used to open the die. The pump handle is now ready.

NOTE: If the pump die is not in the correct position, the die will not open. Please refer to the manual for more information.

WARNING
Read and understand all instructions covered in the Piranha® hydraulic sewage machine manual before using.
Failure to do so could result in injury or death. This machine is certified to only mending Piranha® sewer cleaning hose.
Any other use is at the liability of the user.



Piranha Hose Products, Inc.
A Kuriyama Group Company
2500 Weigel Street
Cadillac, MI 49601
Phone: 1-800-250-5132

PHP110 Ultra Mending Machine

Ref.	Part Number	Description	Quantity
1.	PHP 0700-100	Wheel swage machine	2
2.	PHP 2500-1.5	Shoulder bolt 1/2" x 1 1/2" long	2
3.	PHP 0501-311	Washer flat 1/2" SAE-zinc	2
4.	PHP 110.013	5/16-18 x 1 1/4" soc. hd. cap screw	3
5.	PHP 110.113	1" Pipe coupling kickstand pipe	1
6.	PHP 110.102	Base ultra swage machine	1
7.	PHP 110.112	1" Gal. x 18" L pipe t.o.e. kickstand	1
8.	PHP 110.002	12 Ton bottlejack	1
9.	PHP 110.110	Truss rod Ultra Swage Machine	2
10.	PHP 110.011	Spring Ultra Swage Machine	1
11.	PHP 110.104	Lower die holder frame Ultra	1
12.	PHP 110.111	Top die holder Ultra	1
13.	PHP 110-114	3/8-16 x 1" Hex hd bolt Grade 8	1
14.	PHP 0375-100	3/8" Lock washer	1
15.	PHP 110.017	3/8" Flat washer	1
16.	PHP 750-217	3/4" Flat washer AN960-1216	2
17.	PHP 750-216	3/4-16 Nut hex zinc plated	4
18.	PHP 0500-100	1/2 Lock washer	2
19.	PHP 110.016	1/2-13 x 1" Hex head cap screw	2
20.	PHP 110.106	Handle support Ultra Swage	2
21.	PHP 0500-100	1/2 Lock washer	2
22.	PHP 110.016	3/8-16 x 3/4" Hex head cap screw	2
23.	PHP 110.107	Handle alum Ultra Swage	1
24.	PHP 110.001	Handle grip	1
25.	PHP 110.114	Petcock/Jack handle	1
26.	PHP 110.015	5/8-11 x 4" Soc. head cap screw	2
27.	PHP 110.012	1/2" Hex wrench long arm	1
28.	PHP 110.115A	Decal kit (instructions)	2
29.	PHP 110-manual	Ultra Swage Machine manual	1
30.	PHP 110.121A	1 oz. Die Oil	1
31.	PHP 110.120	Die Oil Brush	1
32.	PHP-HC	Hose Cutter Tool	1
33.	PHP-petcock kit	Screw/O-Ring/Ball	1

Piranha Hose Products, Inc.

A Kuriyama Group Company

2500 Weigel Street • Cadillac, MI 49601 • 1-800-250-5132

Cautionary/Warranty Statements

Cautionary Statement

All products sold and distributed by Piranha Hose Products are in the nature of commodities and they are sold by published specifications and not for particular purposes, uses, or application. Purchaser shall first determine their suitability for the intended purposes, uses or applications and shall either conduct its own engineering studies or tests, or retain qualified engineers, consultants or testing laboratories and consult with them before determining the proper use, suitability or propriety of the merchandise or Products for the intended purposes, uses, or applications. Piranha Hose Products ("Seller") does not recommend that the Products for any particular purpose, use or application, and the Purchaser or user thereof shall assume full responsibility for the suitability, propriety, use and application of the Products. Purchaser shall follow all instructions contained in Seller's catalogs, brochures, technical bulletins and other documents regarding the Products. The Products, including but not limited to, hose, tubing or couplings, may fail due to the use or conveyance of substances at elevated or lowered temperature or at excessive pressure, the conveyance of abrasive, injurious, flammable, explosive, or damaging substances. Hose or tubing used in bent configurations will be subjected to increases abrasion. Hose clamps or couplings may loosen after initial installations and all sections of hose and tubing including connections, couplings, clamps, conductivity, and bonding should be inspected frequently, regularly, consistently, and should be replaced, adjusted or re-tightened for the avoidance of leakage, for the prevention of injuries or damages, and for general safety purposes. Except as indicated in its Limited Warranty. Seller shall not be liable or responsible for direct or indirect injuries or damages caused by or attributed to the failure or malfunction of any Products sold or distributed by it. Purchasers or users of the Products should frequently and consistently undertake inspections and protective measures with respect to the use and application of Products, which should include the examination of tube and cover, conditions of the hose or tubing, and the identification, repair or replacement of sections showing cracking, blistering, separations, internal and external abrasions, leaking or slipped couplings or connections and make proper proof tests.

Limited Warranty

The Products sold or distributed by Seller are warranted to its customers to be free from defects in material and workmanship at the time of shipment by us, subject to the following provisions. ALL WARRANTY CLAIMS SHALL BE MADE WITHIN SIX (6) MONTHS AFTER SELLER SHIPPED THE PRODUCTS. SELLER'S LIABILITY HEREUNDER IS LIMITED AT SELLER'S EXCLUSIVE DISCRETION, TO 1) THE PURCHASE PRICE OF ANY PRODUCTS PROVIDING DEFECTIVE; 2) REPAIR OF ANY DEFECTIVE PRODUCT OR PART THEREOF; OR 3) REPLACEMENT OF ANY DEFECTIVE PRODUCT OR PART UPON ITS AUTHORIZED RETURN TO SELLER. THIS WARRANTY IS IN LIEU OF AND EXCLUDES ALL OTHER WARRANTIES, EXPRESSED, IMPLIED, STATUTORY, OR OTHERWISE CREATED UNDER APPLICABLE LAW INCLUDING, BUT NOT LIMITED TO, THE WARRANTY OF MERCHANTABILITY AND THE WARRANTY OF FITNESS FOR A PARTICULAR PURPOSE. IN NO EVENT SHALL SELLER OR THE MANUFACTURER OF THE PRODUCT BE LIABLE FOR SPECIAL, INCIDENTAL, OR CONSEQUENTIAL DAMAGES INCLUDING LOSS OF PROFITS, WHETHER OR NOT CAUSED BY OR RESULTING FROM THE NEGLIGENCE OF SELLER AND/OR THE MANUFACTURER OF THE PRODUCT, UNLESS SPECIFICALLY PROVIDED HEREIN. IN ADDITION, THIS WARRANTY SHALL NOT APPLY TO ANY PRODUCTS OR PORTIONS THEREOF WHICH HAVE BEEN SUBJECTED TO ABUSE, MISUSE, IMPROPER INSTALLATION, MAINTENANCE, OR OPERATION, ELECTRICAL FAILURE OR ABNORMAL CONDITIONS, AND TO PRODUCTS WHICH HAVE BEEN TAMPERED WITH, ALTERED, MODIFIED, REPAIRED, REWORKED BY ANYONE NOT APPROVED BY SELLER, OR USED IN ANY MANNER INCONSISTENT WITH THE PROVISIONS OF THE "CAUTIONARY STATEMENT" ABOVE OR ANY INSTRUCTIONS OR SPECIFICATIONS PROVIDED WITH OR FOR THE PRODUCT.

PHPCA0409



2500 Weigel St.
Cadillac, MI 49601
www.piranhahose.com - sales@piranhahose.com
(231) 779-4390 - (800) 250-5132